



# AIRBRASIVE® UNIT MODEL H SERIES II 220V/50Hz AU213

Service Manual

Operation & Maintenance Instructions with Illustrated Parts List

Airbrasive Jet Technologies, LLC  
200 School Alley Suite 7  
Green Lane, PA 18054

Email: [info@airbrasive.com](mailto:info@airbrasive.com)  
Phone: (866) 272-0540

[www.airbrasive.com](http://www.airbrasive.com)

Revised: December 2022

# Overview

## AIRBRASIVE® MICRO ABRASIVE BLASTING TECHNOLOGY

Airbrasive® Jet Machining is a process in which high pressure air and very fine powder are blended in a chamber to form an abrasive mixture. This mixture is then sent through a small, precisely machined nozzle. The result is a highly accurate abrasive stream that can be used for cleaning, cutting, drilling, deburring, and finishing all types of surfaces. Airbrasive® Machines have limitless applications. These highly engineered machines are incredibly versatile. They have the power to cut and drill materials as hard as diamonds, as well as the precision to delicately clean debris from ancient papyrus documents.

## OPERATING PRINCIPLES

The Airbrasive® Machine is capable of many cutting and abrading tasks. From cutting very hard materials such as diamonds to cleaning extremely delicate items like fabric or paper. The key to taking advantage of its versatility is the knowledge of how it cuts. Knowing this, you can properly set the various controls to achieve your desired cutting results. There are six key variables involved in the cutting process. 1) Air Pressure, 2) Powder Flow Rate, 3) Nozzle Size, 4) Type of Powder, 5) Nozzle Distance from work piece, and 6) Angle of Impingement.

## AIR PRESSURE

The air pressure is directly related to the velocity of the powder particles striking your work piece. The higher the air pressure the faster the particles and the greater the cutting speed. The lower the pressure the, lower the cutting speed. This is not a linear correlation. There are certain critical points you will notice as you experiment with different air pressure settings. When the particle velocity falls below a certain level the cutting action may suddenly stop altogether. Similarly, a small increase in air pressure may gain a large increase in cutting action. The air pressure is limited at the high end by safety concerns and by what your main air supply can produce.

**The unit should never be pressurized beyond 140 PSI!**

## POWDER FLOW RATE

The amount of powder exiting the nozzle per minute is referred to as the flow rate. The greater the flow rate, the greater the cutting action. To achieve the better cutting action with higher powder flow rates, it is often necessary to increase the air pressure. This is done to maintain particle velocity which tends to slow down as the mass the air stream must carry increases. Cutting action will decrease quickly at very high powder flow rates. This is due to interference between the powder particles bouncing off the work piece and those coming out of the nozzle. Some brief experimentation at these high flow rates will quickly reveal your limits.

## NOZZLE SIZE

Nozzle orifices are shaped to be either round or rectangular. The nozzle widths vary in size from .005 up to .032 inches. The size of the nozzle determines the area that will be impacted by the powder. The larger the nozzle, the greater the area. The shape of the nozzle is important for getting into unusually shaped spaces. A rectangular nozzle can lightly cover a large width or, when turned, heavily impact a narrow space.

## TYPE OF POWDER

The cutting powder is the most important variable in the "Airbrasive" process. It determines the severity with which you will impact your part. Some powders are designed for aggressive removal of material while others for a gentle cleaning. To achieve consistent, sputter free smooth flow it is necessary to use uniformly sized powder. If the powder particles vary in size, even a little, the powder will tend to clump together. This happens because the smaller particles fill in the gaps between the larger particles, effectively locking them all together. If all the particles are of the same size, then this locking action cannot take place.

## NOZZLE DISTANCE TO WORKPIECE

The distance you hold the nozzle from the work piece plays a large part in determining the area covered as well as the cutting rate.

## ANGLE OF IMPINGEMENT

The angle at which you hold the nozzle regulates the speed and efficiency by which material can be removed from the work piece. There are two theories at play here, one based on material removal by brittle failure and the other on material removal by ductile failure. Brittle failure occurs when impacting powder granules penetrate the work surface and literally blast particles out of it. Ductile failure occurs when the powder granule strikes the work surface at an angle of less than 90 degrees and removes material by generating a chip.

Tests have shown that maximum material removal for ductile materials occurs between a 15- and 45-degree angle of incidence. For a brittle material, maximum removal occurs at an angle of 90 degrees.

# Section 1: Introduction and Description

## INTRODUCTION

A. Scope. This technical manual contains operation and service instructions, as well as an illustrated parts list for the Airbrasive® Model H Series II manufactured by Airbrasive Jet Technologies, LLC.

B. Characteristics. The Airbrasive® Model H Series II is an electrically powered device that incorporates a patented electro-magnetic vibratory feed system for powder delivery. The Model H series II unit has been designed to accommodate both the intermittent and continuous production demands of high-volume producers.

## SPECIFICATIONS

1. Air Supply Requirements	110 ± 30 PSI (0.5 CFM @ 80 PSI min., 140 PSI max.) Dry, clean, compressed air, carbon dioxide, or nitrogen.
2. Electrical Power Requirements	AU213: 220V, 50HZ, Single Phase, Three Wire The plug supplied is three-prong, polarized, providing an earth ground.
3. Weight	60 lbs. (27.27 kg)
4. Dimensions	22-1/2" x 14-7/8" x 9-5/8" (H x W x D) 57.2 cm x 37.8 cm x 24.4 cm (H x W x D)

**WARNING:** The use of oxygen as a gas supply presents the possibility of an explosion occurring. Under no circumstances should oxygen be used.

**IMPORTANT:** A suitable dust collector system is required to maintain operator's exposures to powder dusts below permissible exposure limits such as those regulated by OSHA or recommended annually by ACGIH (American Conference of Governmental Industrial Hygienist). Consult the manufacturer of the dust collector equipment for the correct filter for other dusts or air contaminants resulting from material being abraded.

## AIR SUPPLY NOTE

Many compressed air lines are contaminated with moisture, oil, and dirt, which are detrimental to the performance and operation of the Unit. Moisture filters and unloaders must be used. These items can be purchased directly from Airbrasive Jet Technologies, LLC.

## POWDER NOTE

The MODEL H UNIT is designed to use specially prepared powders that are meticulously screened for uniform particle size. These specialty powders insure smooth flow through the many precision ports and feedthroughs. The use of any other type of powder can result in clogging of the internal components and potential damage to the unit. For more information on these powders, contact Airbrasive Jet Technologies, LLC at (866) 272-0540.

## AIRBRASIVE® MODEL H II: STANDARD EQUIPMENT

Description	Part Number	Quantity
Airbrasive® Model H	AU213	1
Nozzle (Rt. Angle .018" I.D.)	AN118	1
Nozzle (Straight, Round, .018" I.D.)	AN119	1
Nozzle (Straight, Rectangular, .006" x.060")	AN124	1
AccuBrade 27 – Aluminum Oxide	AP101	4 lbs.
AccuBrade 50 – Aluminum Oxide	AP105	4 lbs.

## Section 1a: Description of Components (Sorted Alphabetically by Part #)

### AC107 | AUXILIARY CHAMBER

The purpose of the auxiliary chamber is to store powder and keep the mixing chamber level constant. This allows the mixing chamber to feed a constant amount of powder into the air stream.

### AC118X2 | MIXING CHAMBER ASSEMBLY

When the mixing chamber is vibrated, powder falls through small holes in the orifice plate assembly and is entrained into the air stream flowing through the chamber base. This is where the air and powder are precisely blended into the mixture you need for your application.

### AE104 | FUSE HOLDER SOCKET

### AE130X | POWDER REGULATION ADJUSTMENT

This knob adjusts the voltage being applied to the vibrator/mixing chamber assembly. It regulates the powder flow rate exiting the nozzle

### AE133X | AIR SUPPLY SOLENOID VALVE

With the SYSTEM POWER SWITCH set to "On", this solenoid valve is energized providing the unit with air. When the SYSTEM POWER SWITCH is set to "Off", the valve closes, blocking air to the unit. The valve is not field repairable. Replace if it malfunctions.

### AE182 | POWER OUTLET

Your external power source is connected here.

### AE188 | RELAY

The relay provides a switch function for the operation time and pinch valve actuation indicators.

### AE189 | SYSTEM POWER ON/OFF SWITCH

The master switch for electrical current supplied to the unit. This will initiate bleeding of all pneumatic lines when switched off during use. Allow a minimum of 20 seconds after turning system power off before attempting to open powder chamber; it takes this long for all pneumatic lines to bleed off and reduce pressure in the chamber to safe levels.

### AE190 | CONTINUOUS OR FOOT SWITCH TOGGLE

Set this to CONTINUOUS if you want a steady, uninterrupted stream of powder flow. Set to FOOT SWITCH ACTIVATED if you want to use the foot switch to control the stream of powder flow

### AE191 | OPERATION TIME INDICATOR

A clock which represents the cumulative hours the unit has operated from the time of its purchase. Clock only runs when SYSTEM POWER ON/OFF switch is in the on position.

### AE192 | PINCH VALVE ACTUATOR

A cumulative reading of the number of times the pinch valve has been pinched shut. Use these readings to determine maintenance schedules for the replacement of the pinch tube.

### AE193 | PINCH VALVE SOLENOID

Controls the air pressure to the pinch valve assembly. When the SYSTEM POWER SWITCH is "On", the solenoid allows air pressure to enter the pinch valve assembly. Air enters the bottom of the solenoid, flows through passages and ports to displace the piston which causes the depressor to pinch the tube closed.

#### AE193 | BLEED SOLENOID VALVE

Controls air pressure to bleed valve assembly. When the SYSTEM POWER SWITCH is set to "On", the solenoid allows air to enter the assembly. This closes the pinch tube within the assembly. When the SYSTEM POWER SWITCH is set to "Off", the solenoid blocks the air from entering the assembly, thus opening the pinch tube.

#### AE202 | ELECTRICAL INTERLOCK

Disengages electrical power when the front panel is opened while the unit is plugged into an electrical outlet. When the front panel is opened a limit switch opens the main electrical circuit, disabling the unit (the unit cannot be pressurized with the cover open).

**WARNING: Some components are still connected to your external power source. The main power cord should always be disconnected before servicing the unit.**

#### AE204 | FOOT SWITCH RECEPTACLE

Attach the foot pedal to this outlet.

#### AE236 | POWDER LEVEL SENSOR

The powder refill sensing circuit provides automatic indication of low powder level in the mixing chamber. When powder level is low, the sensor sends a signal to the pilot light on the front panel to warn the user to fill the auxiliary chamber with powder.

#### AG103 | PINCH VALVE PRESSURE GAUGE

This shows the pressure that the pinch valve assembly is set at. It is the pressure being applied to the "pinch tube" to cut off powder flow when the unit is being used in the FOOT SWITCH ACTIVATED mode. The adjustment for this setting is located inside the unit.

#### AG107 | POWDER REGULATION GAUGE

A relative measurement of how much powder is entering the flow stream. The gauge measures voltage being applied to the vibrator/mixing chamber assembly. The higher the voltage, the greater the vibration and resultant powder flow.

#### AG111 | CHAMBER PRESSURE GAUGE

A measure of the air pressure in the mixing chamber, auxiliary chamber. This is the air pressure that will be seen at the nozzle. Do not attempt to open auxiliary chamber to refill powder until this gauge reads "0 PSI". This gauge is not repairable and should be replaced with a new one if it malfunctions

#### AH110X | HAND PIECE HOSE

The hose leaving the pinch tube assembly, passing through the front panel and connecting to the handpiece. The regulated air/powder mixture runs through this hose to the nozzle.

#### AQ104 | AIR OUT FITTING

A hose is provided from the back panel to bleed pressure from the system when refilling powder or performing maintenance. This hose should be routed to an appropriate dust collection system.

#### AQ205 | AIR IN

External air source is connected here.

#### AR133 | INTERLOCK CYLINDER

When the unit is pressurized, the interlock cylinder rod extends outward, locking the top cover to prevent opening. When the air supply solenoid valve blocks air flow, and the unit is bled, the cylinder rod retracts allowing the cover to be opened.

**WARNING: This prevents opening the auxiliary chamber when pressurized – which is dangerous.**

**WARNING: An Interlock is provided for increased operator safety and should not be disabled.**

#### AR139 | RELIEF VALVE

If primary system pressure is excessive the relief valve will pop open to reduce it. Once the pressure has been lowered the relief valve will reset automatically.

#### AR140 | CHAMBER PRESSURE ADJUSTMENT

Regulates incoming air line pressure to the desired level in the mixing chamber. This regulates the powder cutting pressure. This regulator is not field repairable. In the event of a malfunction, replace.

#### AR140V2 | PINCH VALVE ASSEMBLY REGULATOR

Controls the amount of air pressure going to the pinch valve assembly. It is normally preset at 40 PSI. This regulator is not field repairable. In the event of a malfunction, replace.

**WARNING: The Pinch Valve Regulator is factory adjusted and locked at 40 PSI. This setting should not be changed. Less pressure will not operate the air pinch valve; more will result in abnormal wear.**

#### AR142Z | PINCH VALVE ASSEMBLY

This assembly provides a path for the air/powder mixture to flow to the handpiece. When the SYSTEM POWER SWITCH is "On", air enters the assembly to depress the pinch tube. This blocks the air/powder mixture to the handpiece. When the foot pedal is depressed or you are in a continuous powder flow mode, the air is bled out of the assembly, thus opening the tube to allow flow.

#### AR142Z1 | BLEED VALVE ASSEMBLY

This assembly allows a bleed path for the auxiliary chamber when the unit is shut down

#### AR182 | LOW POWDER INDICATOR

The Unit has a powder refill sensing circuit. It automatically indicates when the powder in the mixing chamber is low. The probe is mounted between the auxiliary and mixing chamber. When powder is low, the sensor sends a signal to the low powder indicator telling the end user to fill the auxiliary chamber with powder.

#### AR183 | AIR PRESSURE INDICATOR

This tells you if your incoming air line pressure is available.

#### AR186 | LEAK DETECTOR

This pneumatically operated sensor will display a green dot in its window if the pinch tube leaks

#### AV104X2 | VIBRATOR

The mixing chamber is oscillated by the vibrator assembly. The amplitude of vibration is controlled by the POWDER REGULATION ADJUSTMENT knob. The greater the vibration amplitude the higher the powder flow rate.

#### VARIOUS | NOZZLE

Where the powder leaves the unit under pressure. Nozzles come in a variety of shapes and sizes depending on what application you are dealing with.

FRONT PANEL

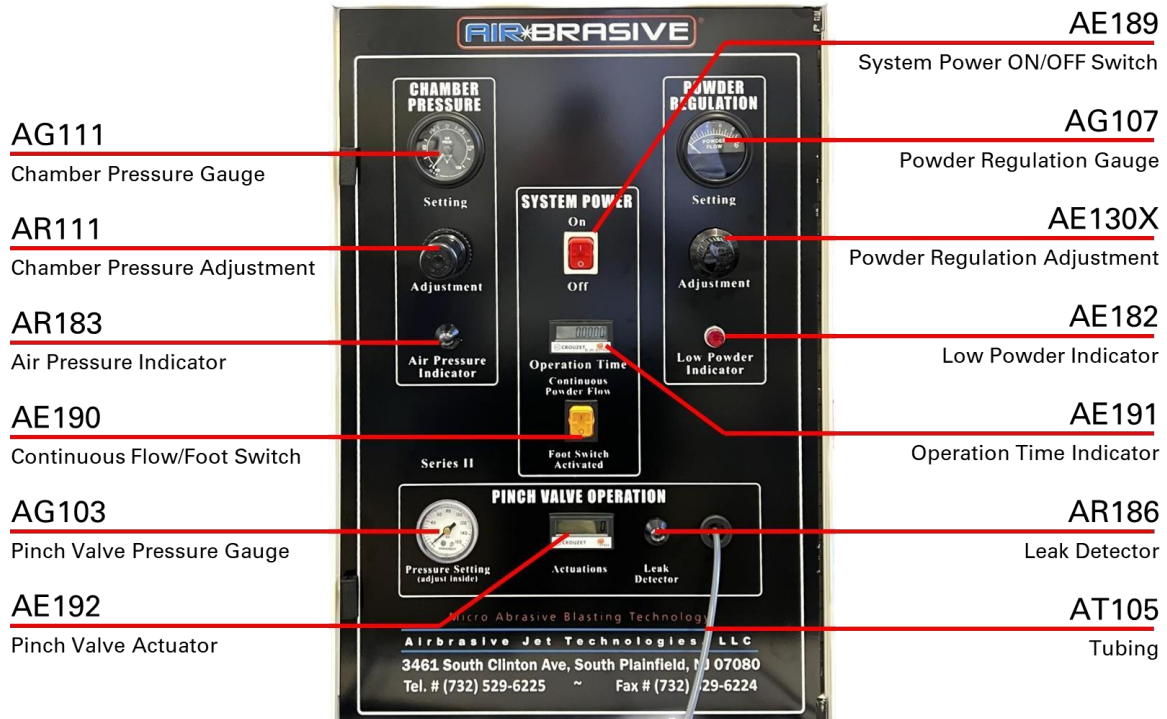

**AG111**  
Chamber Pressure Gauge

**AR111**  
Chamber Pressure Adjustment

**AR183**  
Air Pressure Indicator

**AE190**  
Continuous Flow/Foot Switch

**AG103**  
Pinch Valve Pressure Gauge

**AE192**  
Pinch Valve Actuator

**AE189**  
System Power ON/OFF Switch

**AG107**  
Powder Regulation Gauge

**AE130X**  
Powder Regulation Adjustment

**AE182**  
Low Powder Indicator

**AE191**  
Operation Time Indicator

**AR186**  
Leak Detector

**AT105**  
Tubing

INSIDE THE UNIT

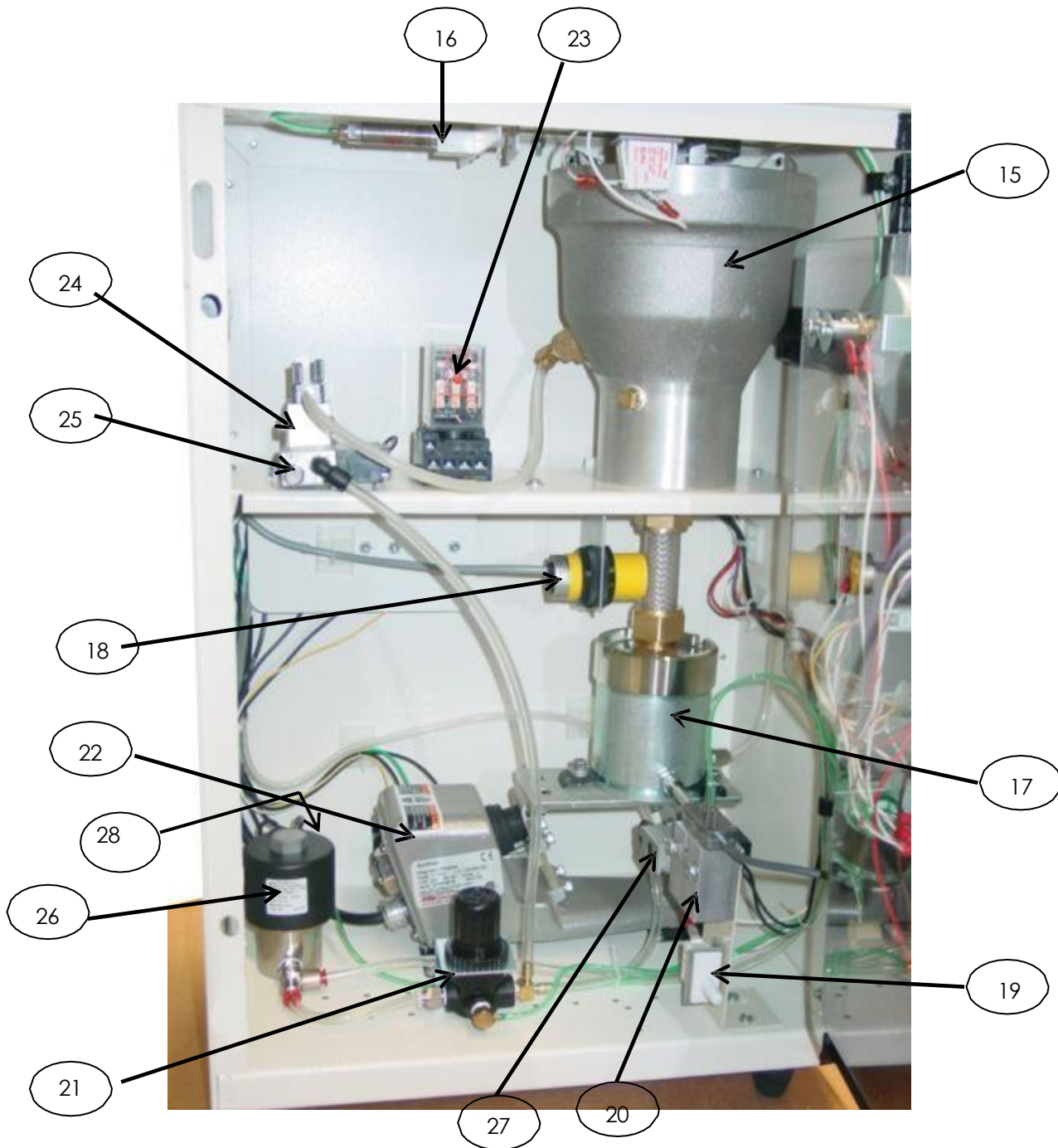

15	Auxiliary Chamber	AC107	22	Vibrator Assembly	AV123X2
16	Interlock Cylinder	AR133	23	Relay	AE221
17	Mixing Chamber Assembly	AC118X2	24	Bleed Pinch Valve Assembly	AR142Z1
18	Powder Level Sensor	AE236	25	Bleed Valve Solenoid	AE193A
19	Electrical Interlock	AE202	26	Main Solenoid Valve	AE133AX
20	Pinch Valve Assembly	AR142Z	27	Pinch Valve Solenoid	AE193A
21	Pinch-Bleed Valve Assy. Regulator	AR140V2	28	Relief Valve	AR139

REAR VIEW



29	Air In Fitting	AQ205	32	Air Out Fitting	AQ104
30	Electric Outlet	AE182	33	Foot Switch Receptacle	AE204
31	Fuse Holder Socket	AE104		Foot Switch (not shown)	AE103X

## Section 2: Installation and Unit Checkout

### INSTALLATION

- A. Attach the BLOW OFF TUBING (plastic tubing shipped with the Unit) to the fitting (32) on the rear of the Unit. Attach the other end of the BLOW OFF TUBING to an available exhaust system to evacuate excess powder from the Unit.
- B. Connect the end of the AIR IN fitting (29) to the external air supply (see page 2 for supply requirements).
- C. Set the SYSTEM POWER ON/OFF Switch (1), on the front panel to "Off", and the POWDER REGULATION SETTING Knob (2), completely counterclockwise.
- D. Connect the provided power cord to the unit's power outlet (30) and plug the other end into an available outlet (see page 2 for electrical requirements).
- E. Set SYSTEM POWER ON/OFF switch to "On".

NOTE: If the SYSTEM POWER ON/OFF switch does not light, it indicates loss of electrical power. Check Unit fuse (31) and if OK, check input power source.

- F. Check reading on the CHAMBER PRESSURE GAUGE (5). Set the main air pressure to desired level by adjusting the CHAMBER PRESSURE ADJUSTMENT regulator (6).
- G. Plug the FOOT SWITCH PLUG in to FOOT SWITCH receptacle (33). Set the CONTINUOUS OR FOOT SWITCH ACTIVATED switch (9) to FOOT SWITCH.
- H. Press foot pedal. Air should flow from the hand piece nozzle.

**CAUTION: Never direct the nozzle towards the face when operating the foot switch. Always use a suitable dust collector system whenever using the unit.**

- I. Set SYSTEM POWER ON/OFF switch to "Off". This bleeds off any residual air remaining in the mixing chamber.

**CAUTION: Keep SYSTEM POWER ON/OFF switch to "Off" for a minimum of 20 seconds each time the Unit is turned off. This will allow enough time to bleed the mixing chamber.**

- J. Install nozzle (14) in hand piece (13).
- K. Place SYSTEM POWER ON/OFF switch to "On" and set POWDER REGULATION ADJUSTMENT knob to obtain the desired amount of powder flow for the operation to be performed (nominal setting for most operations is in MED range of POWDER REGULATION GAUGE).
- L. Set unit to CONTINUOUS OR FOOT SWITCH ACTIVATED as desired to obtain powder flow through the nozzle.

### UNIT SHUTDOWN

Place SYSTEM POWER ON/OFF switch to "Off". Remove hose connection from air supply source.

## Section 3: Operation Instructions

This section includes a description of the operating procedures and controls. The operation instructions also describe the capability and use of the UNIT.

### TURN-ON PROCEDURE

**NOTE:** This procedure applies after the Unit has been installed and checked as described on Page 12.

- A. Set SYSTEM POWER switch to "Off", and rotate POWDER REGULATION ADJUSTMENT knob completely counterclockwise; also set CONTINUOUS POWDER FLOW/FOOT SWITCH to FOOT SWITCH.
- B. Connect AIR IN fitting to an external air supply.
- C. Check that power supply cord is plugged into an electrical outlet.
- D. Set SYSTEM POWER switch to "On". Check that the switch is glowing red.
- E. Check PSI reading on CHAMBER PRESSURE SETTING gauge. Adjust CHAMBER PRESSURE ADJUSTMENT knob as required.
- F. Check that no air flow is coming from the hand piece. This indicates the pinch valve tube is closed. If necessary, adjust pinch valve regulator until there is no flow of air/powder from nozzle of hand piece. When adjusting the pinch valve regulator (21), the front panel must be opened. This opens the ELECTRICAL INTERLOCK (19) which disengages electrical power to the unit. To adjust pressure, the ELECTRICAL INTERLOCK must be held in place. This will mimic the front panel being closed. You may now adjust the regulator (21) until there is no air/powder flow from the regulator.

NOTE: Please adjust slowly. Less pressure will not operate the PINCH VALVE ASSEMBLY; more will result in abnormal wear.

- G. Set SYSTEM POWER switch to "Off".

CAUTION: Do not set pinch valve air pressure too high, it will result in excessive tube wear. Do not direct the hand piece towards the face.

- H. Select and install proper nozzle in hand piece for the operation to be performed.
- I. Check powder in auxiliary chamber (15).
- J. Set POWDER REGULATION ADJUSTMENT knob until POWDER REGULATION SETTING gauge is at desired setting. For normal operation, the gauge should be in MED range.
- K. Set SYSTEM POWER ON/OFF switch to "On". The UNIT is ready for operation.
- L. For continuous powder flow, without actuating footswitch, set CONTINUOUS POWDER FLOW/FOOT SWITCH ACTIVATED switch to CONTINUOUS.

### TURN-OFF PROCEDURES

When turning the unit off for short periods of time, set the SYSTEM POWER ON/OFF switch to "Off" position. If the unit is to be shut down for an extended period, proceed as follows:

- A. Set SYSTEM POWER ON/OFF switch to "Off".
- B. Unplug power supply cord.
- C. Disconnect air supply hose from external source.

## Section 4: Service Instructions & Component Maintenance

### PERIODIC INSPECTION

This unit should be inspected periodically for the following signs of wear.

- A. Damaged case or top cover.
- B. Frayed or worn hoses.
- C. Frayed or broken wires.
- D. Blown indicator lamp.
- E. Worn nozzle.
- F. Loose hose connections.

### PERIODIC CLEANING

- A. Clean out dust, dirt, and spilled powder from the Unit's interior using low pressure compressed air. Remove stubborn dirt with a brush. Do not use cleaning fluid on the hoses.
- B. Clean the external surface with a soft lint-free cloth moistened with a suitable non-toxic cleaning solution.

### NOZZLE TIPS

A 3/64" I.D. nozzle tip supplied with the unit (See page 5), and made of sintered tungsten carbide, must be handled with care. Nozzle tips for special applications are available. Nozzle tips wear through the bore enlarging the side wall and piercing through. A fuzzy air powder stream, with lack of definition, is a sign that the nozzle is worn and should be replaced. Replace a nozzle by unscrewing the tip from its connector and replace with a new one. Screw the new nozzle securely to the hand piece connector to avoid powder leaks.

**CAUTION: Nozzle tips are manufactured of sintered tungsten carbide and may break if not carefully handled. They should be stored in a safe place when not in use.**

On occasion the nozzle will clog due to an excessive flow of powder. Unclog a nozzle as follows:

- A. Remove the nozzle from its connector. Blow out obstruction using shop air hose, or
- B. Turn the POWDER REGULATION ADJUSTMENT knob completely Counterclockwise (CCW).
- C. Hold the tip end of the nozzle tight against the connector.
- D. Turn the unit on and actuate the foot switch, supplying air to reverse flush the clogged tip. This should be
- E. done in an exhaust chamber.

### PINCH VALVE TROUBLESHOOTING

If the pinch valve fails to operate properly the problem could be caused by the solenoid or foot switch. Low voltage across the solenoid coil will cause it to hum and not click. Check the voltage across the solenoid coil. If it is low, check the power line voltage. If line voltage is correct check for a drop across the foot switch contacts. If there is a drop replace the foot switch. If not, replace the solenoid. If the pinch valve tube stays open when the unit has air, troubleshoot as follows:

- A. Remove the bottom hose connection from the pinch valve and check if there is air pressure. It should be 40 PSI. If the pressure is incorrect adjust the pinch solenoid regulator (27). If no adjustment is possible replace the regulator.
- B. If pressure is available remove and disassemble the pinch valve assembly. Clean parts and replace any that are worn or damaged. (See drawing: Page 20).

The rubber pinch valve tube wears and will eventually leak. The valve does not have to be removed from the Unit for tube replacement which is accomplished as follows: (See drawing; page 20)

- A. Set SYSTEM POWER ON/OFF switch to "Off" position.
- B. Disconnect hoses from air pinch valve tube.
- C. Remove top block from assembly by removing two knurled screws. Remove worn pinch valve tube from bottom block. Carefully insert the new pinch valve tube into the bottom block indentation. Align the pinch tube's seam to the side of the block.
- D. Carefully replace top block, again making certain that the tube aligns with the indentations in the top block. Secure top block in place with attaching hardware.
- E. Connect hoses removed in step (b) above.
- F. Turn Unit on and check for proper operation with no air leaks.

#### POWDER REGULATION ADJUSTMENT KNOB

The powder flow rheostat adjusts the magnetic coil voltage level. If it malfunctions check electrical connections at the rheostat. If this is not the problem, check operation as follows:

- A. Connect a voltmeter across the input to the magnetic coil of the vibrator assembly.
- B. Turn the POWDER REGULATION ADJUSTMENT knob completely counterclockwise.
- C. With the SYSTEM POWER ON/OFF switch set to "On" and the foot switch actuated, observe the reading on the POWDER REGULATION SETTING gauge while slowly turning the POWDER REGULATION ADJUSTMENT knob CW. The range of the gauge reading from completely CCW to fully CW should be from low to high.
- D. If the gauge reading in step (c) above does not indicate any change over a wide range of knob movement and then suddenly jumps to maximum reading, it indicates faulty wiper arm contact or an open winding in the rheostat. Replace rheostat; the item is not field repairable.

#### VIBRATOR

Each vibrator assembly (22) is factory adjusted to produce the desired vibrating characteristic.

**CAUTION: The POWDER REGULATION ADJUSTMENT knob should never be set too high. This will cause audible striking of the pole pieces by the magnetic coil armature. It will create an excessive amount of vibration that could cause damage to the Unit.**

If the Vibrator does not function properly while under warranty, it must be removed and returned to Airbrasive Jet Technologies, LLC, for readjustment and/or repair. To remove the assembly, disconnect all electrical wires and pneumatic hoses (and tag) from the vibrator (22) and mixing chamber (17). The vibrator and mixing chamber assemblies can now be lifted directly from the multi-plane mounting shock absorbers. Detach the mixing chamber from the vibrator by removing the attaching hardware. To reassemble and install reverse the above procedure. After installation, check the Unit for proper operation with no leaks.

#### AUXILIARY CHAMBER AND MIXING CHAMBER

The auxiliary chamber (15) and mixing chamber (17) function together. The purpose of the auxiliary chamber (which is mounted above the mixing chamber) is to store powder and keep the mixing chamber level constant. This allows the mixing chamber to feed a constant amount of powder into the air stream. The auxiliary chamber doesn't vibrate, mixing chamber vibratory motion is absorbed by the hose assembly (which joins the two chambers together) resiliency. Powder flow rate is determined by air pressure level (set by CHAMBER PRESSURE ADJUSTMENT knob) and vibration amplitude (controlled by the POWDER REGULATION ADJUSTMENT knob) imparted on the mixing chamber by the vibrator assembly.

#### AUXILIARY CHAMBER AND MIXING CHAMBER MAINTENANCE

The auxiliary chamber (15) does not normally require maintenance unless a new O-ring is needed. When removing the O-ring make certain the old one is completely removed from its groove, and no parts of it fall into the chamber. If they do, remove them. (See detailed drawing; pages 21 & 22).

**CAUTION: The O-ring must be seated in its groove when top cover is secured. If the ring is not properly installed, air leaks will occur.**

It is normally not necessary to remove the mixing chamber (17) unless the powder cakes (due to excessive moisture in the compressed air) or the orifice plate needs replacement. If it is necessary, proceed as follows:

- A. Mark the position of the mixing chamber on the vibrator (22). This is necessary, so when reassembling, it is not put in another location causing the vibrator to change its vibratory characteristics. This will also prevent stretching and kinking of air and powder hoses. (See pages 21 & 22)
- B. Remove the one screw that retains the mixing chamber to vibrator via the small cleat. Loosen the other two screws from the larger double cleat.
- C. Loosen the three screws which retain the base cap of the mixing chamber.
- D. Remove hoses going to mixing chamber after tagging them. Make sure you do not lose the fiber washers on the hose nut fittings.
- E. With the mixing chamber upright in the vise, reach into the mixing chamber and grasp the tube portion of the orifice plate assembly and push the assembly out through the base.
- F. Remove the base cap.
- G. Position a container under the chamber and remove the orifice plate, and shake the mixing chamber, causing the powder to fall into the container
- H. Clean the orifice plate, if required, with a fine wire brush and low pressure compressed air. Replace the gasket.

To reassemble, reverse the above procedure, making certain the base cap gasket is properly seated and the chamber located to its scribed position. Clean away any powder that has fallen into the vibrator assembly or Unit itself.

## Section 5: Service Tips

### FLOW DIFFICULTIES

Powder flow difficulties may be caused by the following:

- A. Worn or clogged nozzle tips.
- B. Overfilled or nearly empty mixing chambers. Both conditions can cause an increase in powder flow. When the foot switch is first actuated an initial heavy burst of powder is usually seen for a fraction of a second. This momentary heavy mix is normal. It is due to small amounts of settled powder in the line. A slightly heavier than normal flow is also noticeable after the mixing chamber has been filled.
- C. Reused, contaminated, or improper powders. Such powders can decrease flow or clog the Unit completely, especially at the mixing chamber orifices and at the hand piece nozzle. Never reuse powder. Use of Airbrasive's ABRASIVE Powders exclusively is recommended. We strongly recommend against the use of other commercial powders because they are rarely classified adequately for use with the AIRBRASIVE apparatus, causing needless maintenance and repairs. They may also have toxic substances present which could be harmful to your health.
- D. Insufficient nozzle pressure, usually due to leaks, will reduce cutting speed.
- E. Leaks around the mixing chamber, auxiliary chamber cap, and at fittings may increase powder flow. This condition exists especially at low voltage (Powder Flow control knob set at lower range) and when the footswitch is actuated intermittently every second or so.
- F. Leaks around the base of the mixing chamber can result in decreased powder flow.
- G. Visible leaks which can be detected by the pressure of powder.
- H. Inoperative vibrator caused by broken, loose, or shorted magnetic coil leads.
- I. Loose or broken vibrator springs or improper vibrator adjustment.

### TESTING FOR LEAKS

Leakage may affect its performance and cause an excessive use of powder. The following service tips should be observed:

- A. To check for total system leakage, turn on air pressure until the system is pressurized. Shut off the external air supply valve and observe the Chamber Pressure Setting gauge. If pressure does not drop more than 15 PSI during five minutes, the system leakage is less than one cubic foot per hour. This is negligible.
- B. Most leaks are traced by ear, touch, or the use of soap and water. The presence of powder can indicate a leak.
- C. To check for leakage at the auxiliary chamber top cover, have the chamber pressurized, and apply soap and water. Look for leakage bubbles. Be certain to wipe off all traces of the soap after test completion.
- D. Auxiliary chamber and mixing chamber gaskets are subject to leakage and require periodic replacement.
- E. Make certain that the small nylon gaskets in the hose fittings are in place.
- F. With the system pressurized and the air pinch valve tube closed, leakage through the pinch valve tube should not exceed three bubbles per second with the nozzle tip immersed in water.

## Section 6: Troubleshooting

TROUBLE	POSSIBLE CAUSE	REMEDY
1. With SYSTEM POWER ON/OFF switch "On", switch doesn't light.	a. Blown back panel fuse.	a. Replace fuse.
	b. Switch burnt out.	b. Replace switch.
	c. No input power.	c. Check external input power.
2. With SYSTEM POWER ON/OFF switch "On" and with external air connected to unit, rotation of Chamber Pressure Adjustment does not change PSI reading on Chamber Pressure Setting.	a. Inoperative air pressure regulator.	a. Turn Powder Regulation Adjustment fully counterclockwise. Operate footswitch and check for air flow at nozzle tip. Vary Chamber Pressure from fully counterclockwise to fully clockwise. A definite change in air flow should be noted at the nozzle tip as the knob is rotated its full range. If not, replace air pressure regulator.
	b. Inoperative air pressure gauge.	b. Replace gauge.
3. Traces of powder at pinch valve.	a. Ruptured air pinch tube.	a. Replace tube (see page 20).
4. No air flow at nozzle tip with unit on and foot switch actuated. (Chamber Pressure gauge shows PSI.)	a. Nozzle tip clogged.	a. Clean nozzle tip.
	b. Inoperative pinch valve solenoid.	b. Check solenoid operation.
5. Air flow at nozzle tip when Continuous Powder Flow/Foot Switch Activated switch is in foot switch position and foot switch is not actuated.	a. Shorted foot switch.	a. Check foot switch operation (See Schematic: page 24).
	b. Loss of air supply from pinch solenoid regulator to pinch solenoid valve.	b. Remove hose from bottom of pinch valve and check for air flow. If no air flow, try to adjust pinch solenoid regulator; if there is air flow, remove and check pinch valve assembly (See page 20).
6. Vibrator Inoperative	a. Open rectifier	a. Connect good rectifier in parallel with rectifier on unit (see schematic page 24). If vibrator operates, replace bad rectifier.
	b. Open Powder Regulation adjustment rheostat	b. Check operation of rheostat.
	c. Vibrator magnetic coil burnt out.	c. Replace vibrator assembly.
7. No powder flow from mixing chamber.	a. Clogged orifice plate in mixing chamber.	a. Remove, disassemble, and clean mixing chamber (see page 22).
8. Powder spray from nozzle tip loses definition.	a. Worn nozzle tip.	a. Replace nozzle tip.

PINCH VALVE ASSEMBLY (AR142Z1)

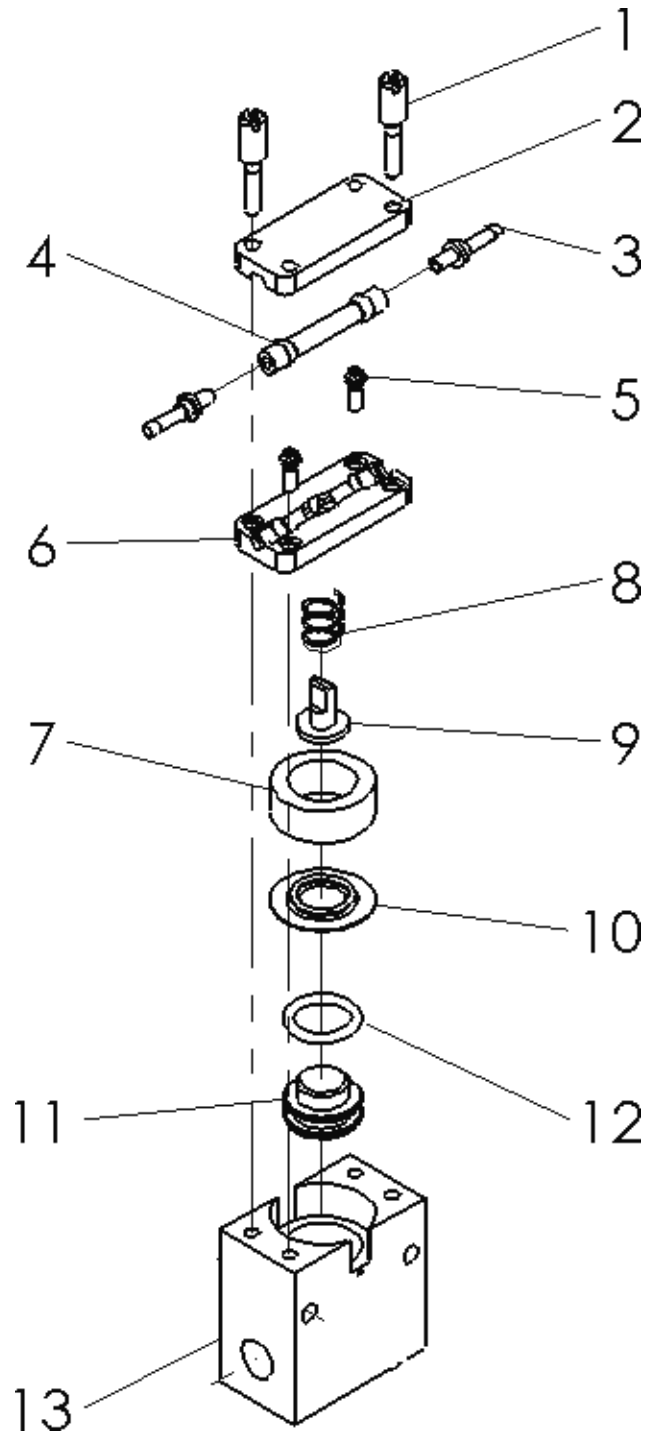

1	Screw, Knurled (2)	AR113	8	Spring	AR126
2	Block, top	AR119	9	Depressor	AR129
3	Hose fitting (2)	AQ130X	10	Diaphragm	AR121
4	Pinch valve	AR142	11	Plunger	AR115
5	Screw, special (2)	AF126	12	O-ring	AO118
6	Block, bottom	AR112	13	Body	AR171
7	Sleeve	AR117			

AUXILIARY CHAMBER AND TOP COVER ASSEMBLY

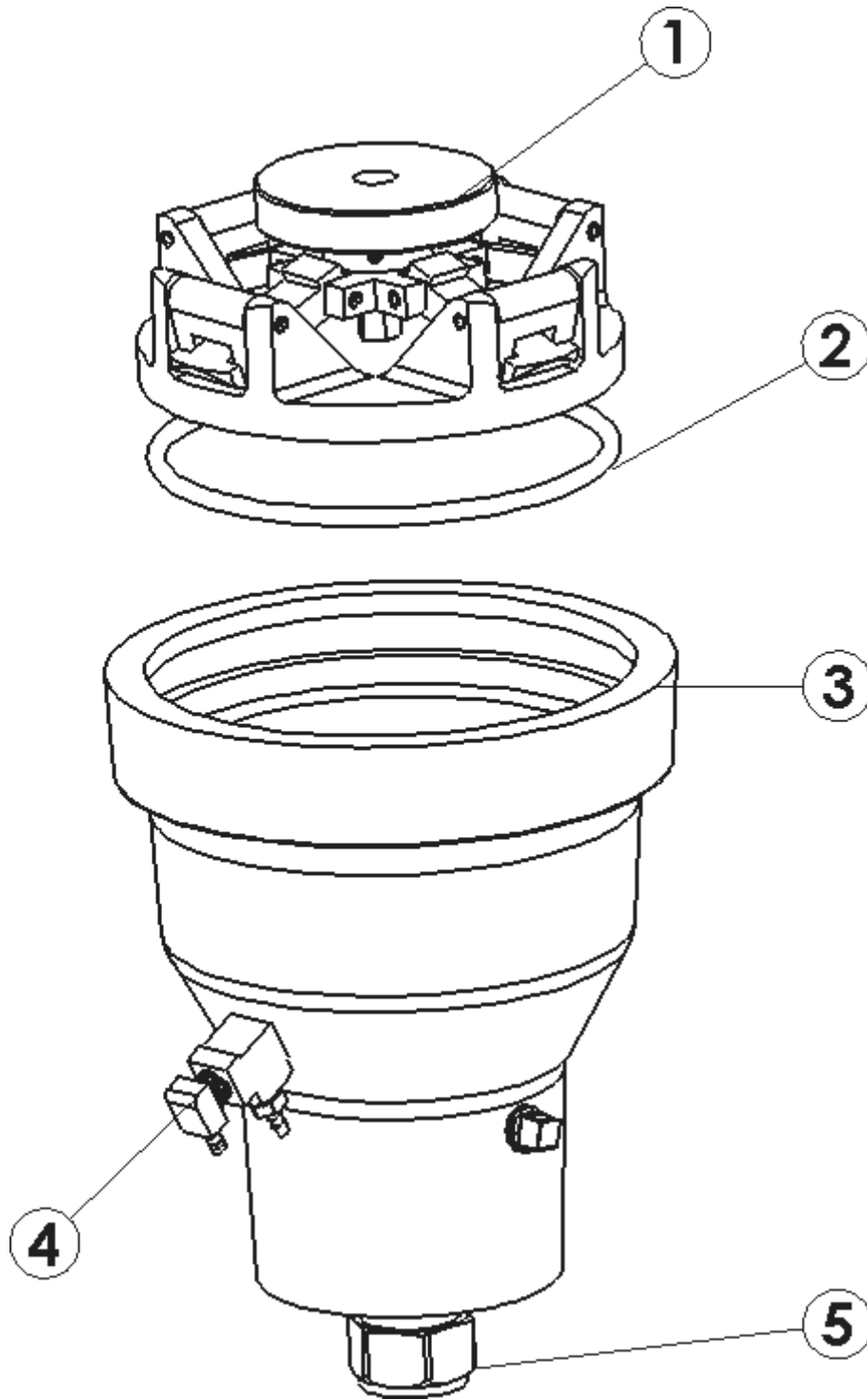

1	Cap Assembly	AC124X	4	Tee Assembly	AQ146X
2	"O" Ring	AO105	5	Coupling	AC115
3	Chamber	AC107			

MIXING CHAMBER ASSEMBLY

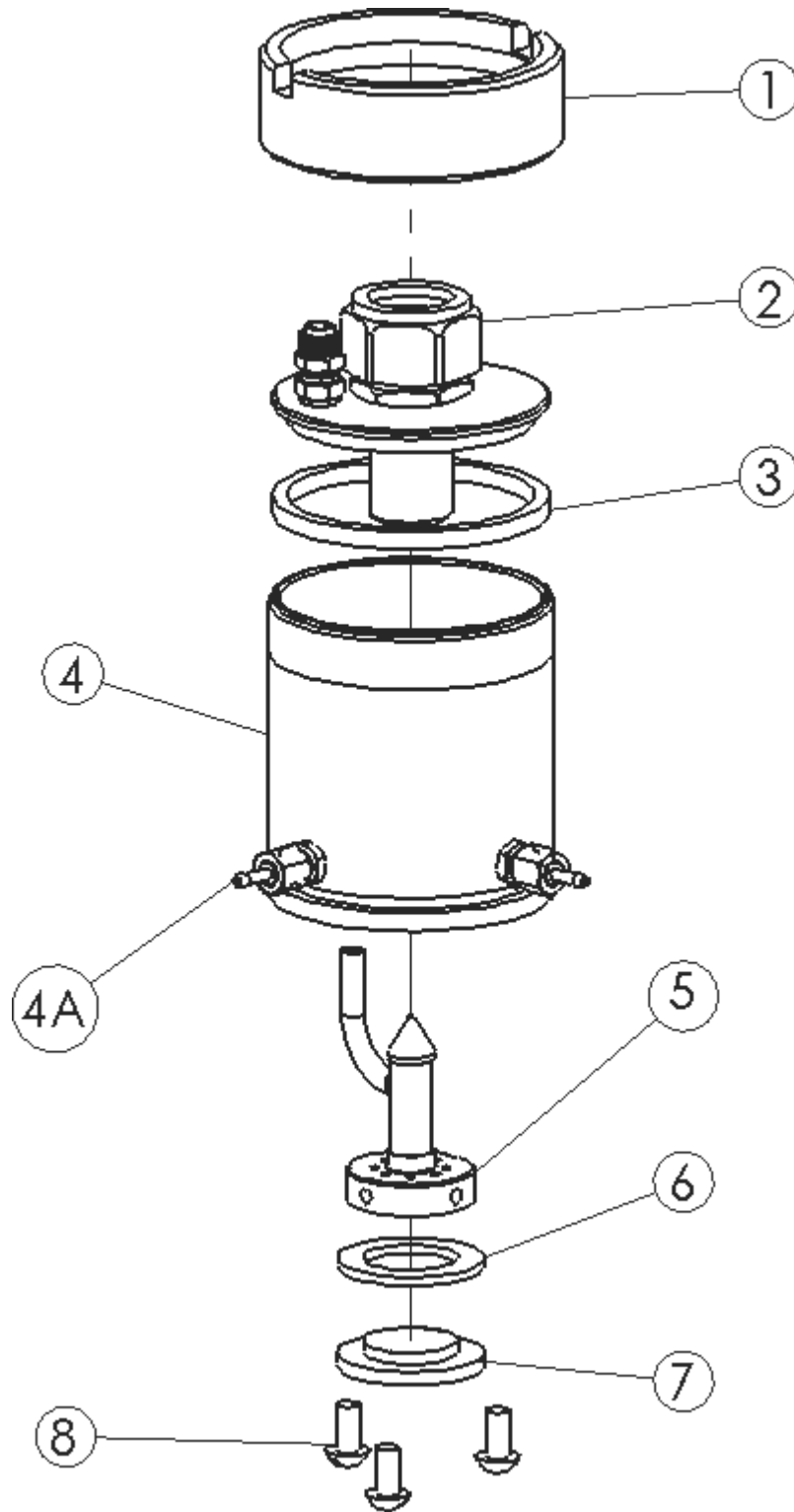

1	Nut Cap	AF402	5	Orifice Plate Assembly	AC106X2
2	Cap Assembly	AC112X	6	Gasket	AO108
3	Gasket	AO111	7	Base Cap	AC114
4	Mixing Chamber	AC118	8	Screw	AF105A
4A	Nipple Assembly	AQ137X			

HAND PIECE ASSEMBLY (AH101Y)

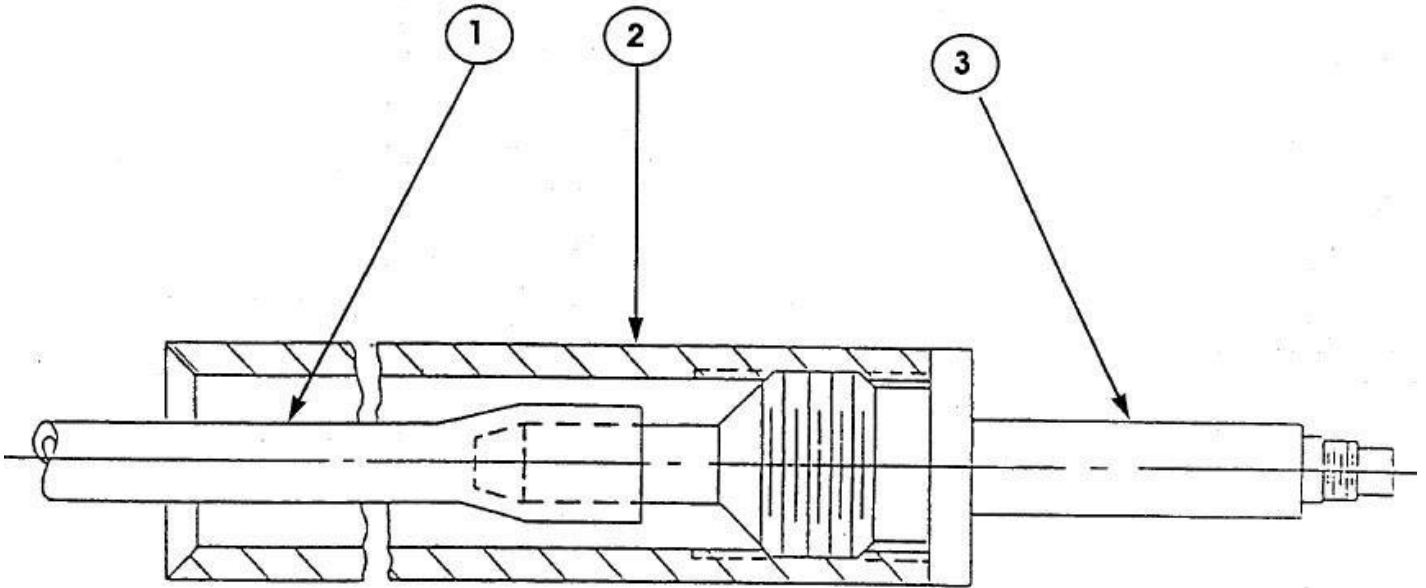

- |    |                            |       |
|----|----------------------------|-------|
| 1. | Tube . . . . .             | AT105 |
| 2. | Handpiece . . . . .        | AH101 |
| 3. | Handpiece End Fitting. . . | AH112 |

# WIRING DIAGRAM

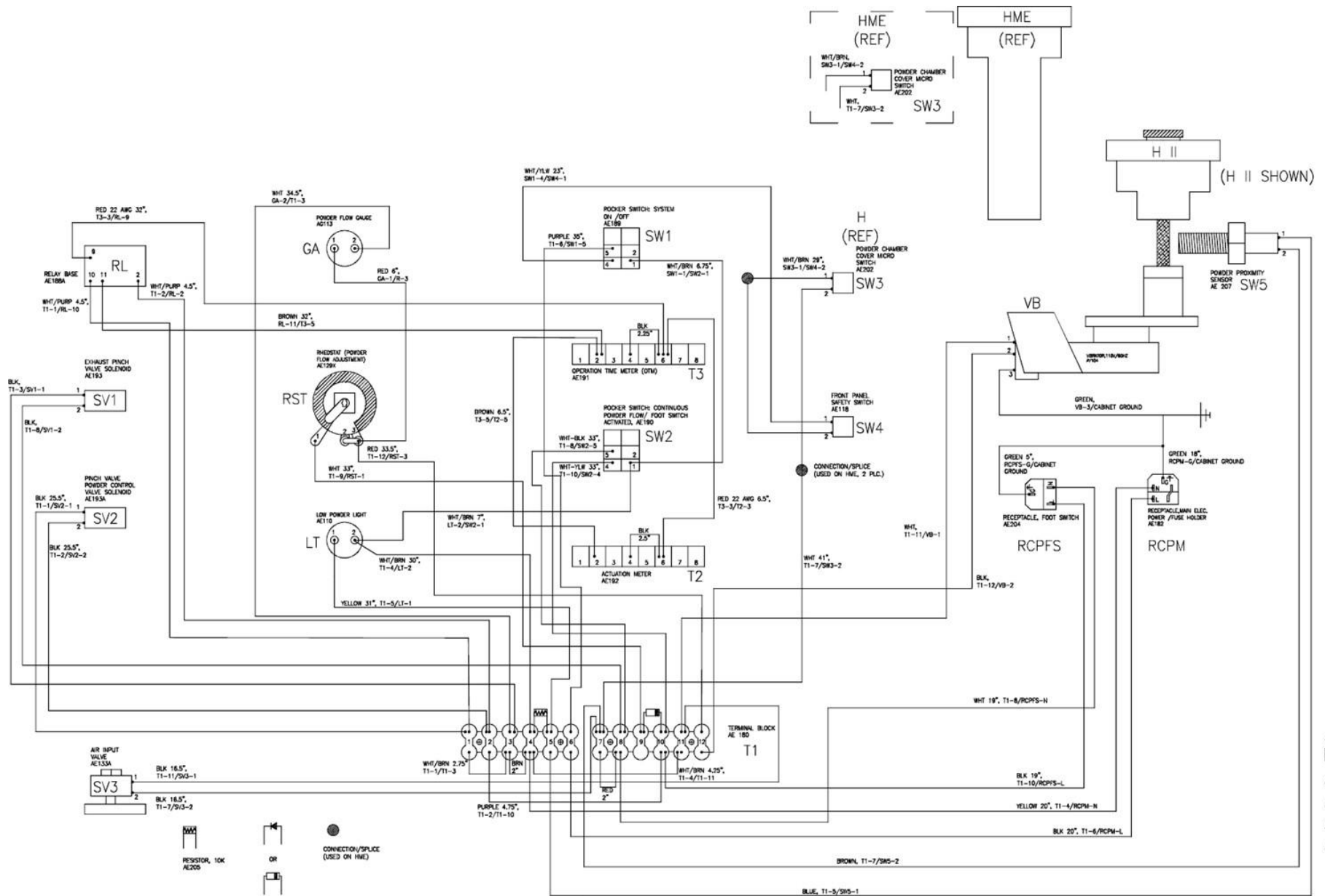

PNEUMATIC DIAGRAM

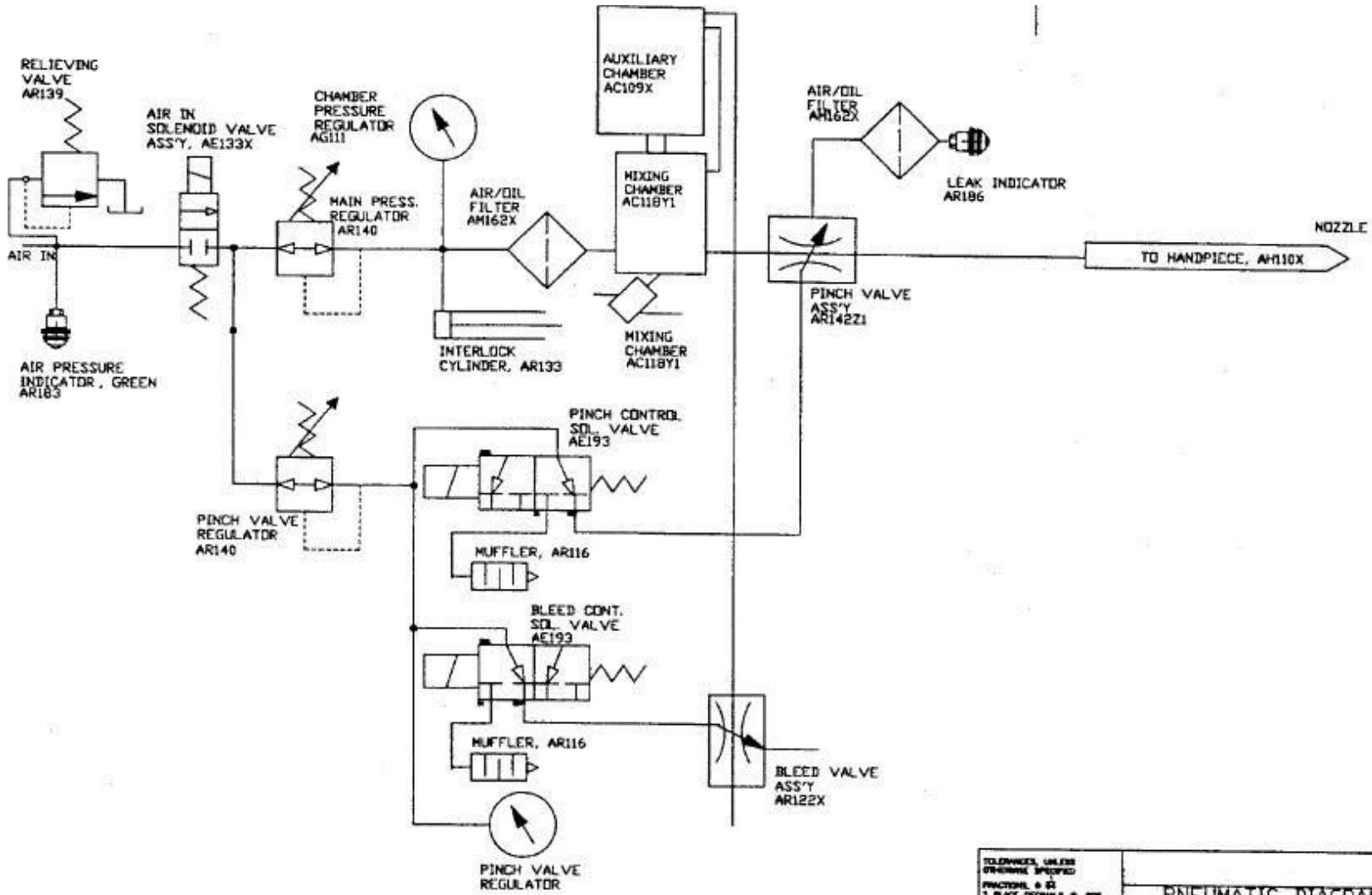

TOLERANCES, UNLESS OTHERWISE SPECIFIED		PNEUMATIC DIAGRAM	
FRACTIONS - 64		MODEL HME II	
3 PLACE DECIMALS - .001		REV. NO.	REV. NO.
ANGLES - 2°		AR197	
DRN: KW	DATE: 8-17-99		

## Airbrasive Model H Tech Sheet

### Model H



### Features

- ✓ Patented vibratory feed system for uniform media flow and precise control
- ✓ Intermittent or continuous duty capability
- ✓ Heavy duty construction
- ✓ Pinch valve shutoff with wear detector
- ✓ Long life fittings at critical wear points

### Description

The Airbrasive Model H gives high volume producers the ability to micro-blast parts on production lines or in labs. This sturdy machine has been designed to accommodate both intermittent (foot switch activated) or continuous operations.

Powder flow lines are reinforced with tungsten carbide fittings for the utmost reliability in a continuous operation. It utilizes our patented vibratory feed for uniform powder flow. Powder flow is adjusted via our powder flow and pressure controls on the front panel.

Added to this machine is an auxiliary powder chamber monitored for powder level. Once it falls below a certain level, an indicator light tells the operator to fill the auxiliary chamber with powder. This guarantees consistent powder flow for continuous operation.

### Specifications

Voltage	110V, 60Hz or 220V, 50Hz
Current	1 Amp
Pressure	Up to 140 PSIG
Min. Line Pressure	50 PSIG
Air Supply	5 SCFM (2.4 L/sec)
Chamber Capacity	4 lb. (1.8 kg) of powder
Powder Flow	Up to 40 grams/min
Orifice Plate	8 holes x 26 mil dia. (0.7mm)
Relief Valve Setting	140 PSIG (9.8 kg/sq. cm)
Dimensions (in.)	22-1/2" x 14-3/4" x 9-5/8"
Dimensions (cm)	57.2 cm x 38.0 cm x 25.0 cm
Weight	60 lbs. (27.2 kg)

## Airbrasive Model H Tech Sheet

### Model H



#### Standard Accessories (Included)

Description	Part #	Qty
Foot Switch Assembly	AE103X	1
Nozzle (Rt. Angle .018" I.D.)	AN118	1
Nozzle (Straight, Round, .018" I.D.)	AN119	1
Nozzle (Straight, Rect., .006" x.060")	AN124	1
AccuBrade 27 – Aluminum Oxide	AP101	4 lb.
AccuBrade 50 – Aluminum Oxide	AP105	4 lb.























#### Recommended Accessories (Not Included)

Description	Part #	Qty
Work Chamber, 110V or 220V	AA106	1
Dust Collector, 110V or 220V	AA122	1
Air / Oil Filter	AA111	1

#### Recommended Spare Parts (Not Included)

Description	Part #	Qty
Nozzle Connect K, H & HME	AH112	6
O-Ring	AO105	1
O-Ring	AO118	1
Nipple Assembly	AQ129X	1
Nipple Assembly	AQ130X	2
Powder Filter Assembly	AR106X	1
Bottom Block, Std. Pinch Valve	AR112	1
Piston (Plunger)	AR115	1
Top Block, Std. Pinch Valve	AR119X	1
Diaphragm	AR121	1
Spring	AR126	2
Depressor	AR129	1
Pinch Tube	AR142	10
Tubing OD: 0.180" ID: 0.092" Grey	AT105	25 ft.

## Nozzle Selection Guide

Nozzle Category	Type A	Type B	Type C	Type D	Type E	Type F	Type G	Type H	Type S	Type T	Adapter
Nozzle Type/Angle	Straight	Industrial	HME Only	90-degree	45-degree	Straight	90-degree	90-degree	Straight	90-degree	Industrial
Tip Material	Carbide	Carbide	Carbide	Carbide	Carbide	Carbide	Carbide	Carbide	Sapphire	Sapphire	
Orifice Shape											
Inner Dia. Outer Dia.											
0.005"	0.034"	AN104									
0.006"	0.020"						AN113				
0.007"	0.150"					AN102					
0.008"	0.040"	AN139				AN130	AN129	AN128			
0.008"	0.060"					AN124	AN136	AN127	AN138		
0.010"	0.030"					AN111					
0.011"	0.052"	AN126									
0.014"	0.035"	AN146									
0.018"	0.053"	AN119	AN117		AN118	AN120			AN143		
0.026"	0.075"	AN122	AN115		AN121				AN107	AN108	Model HME: AN147 Model K or H: AN148
0.032"	0.070"	AN106	AN116		AN109						
0.050"	0.187"			AN145							
0.075"	0.187"			AN145T75							

Our Customer Service team is always available to ensure your complete satisfaction. Please contact us at (866) 272-0540 or at [info@airbrasive.com](mailto:info@airbrasive.com) for general inquiries or price quote requests, and one of our team members will respond within 24 hours.

## Handpiece Diagrams

### Model K

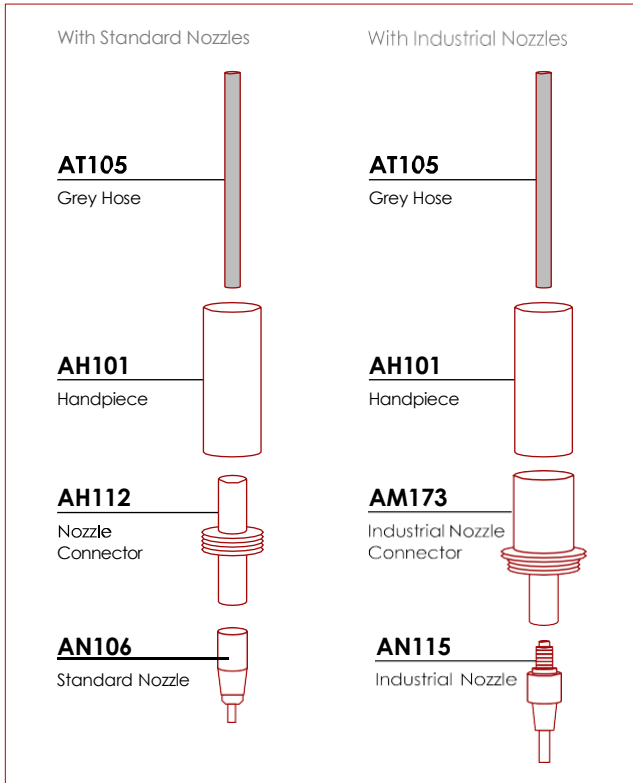

### Model H

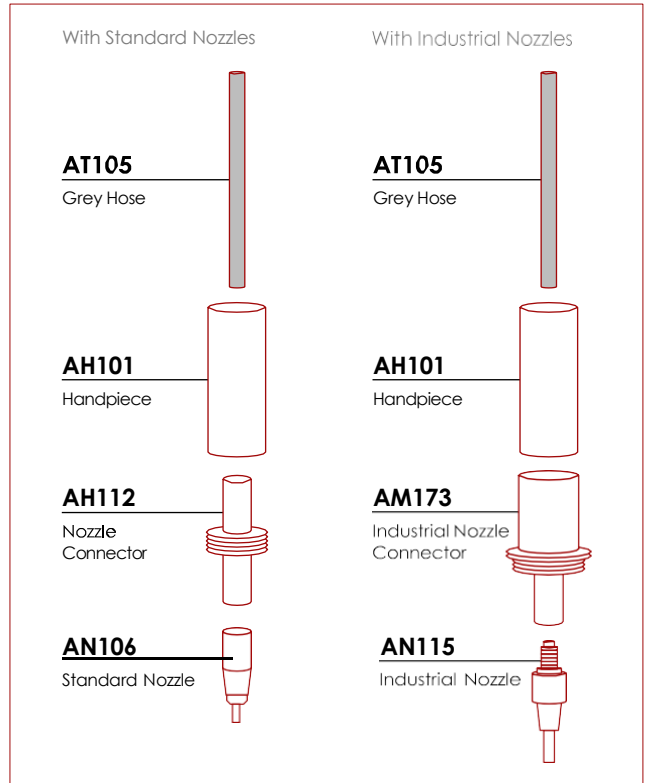

### Model HME

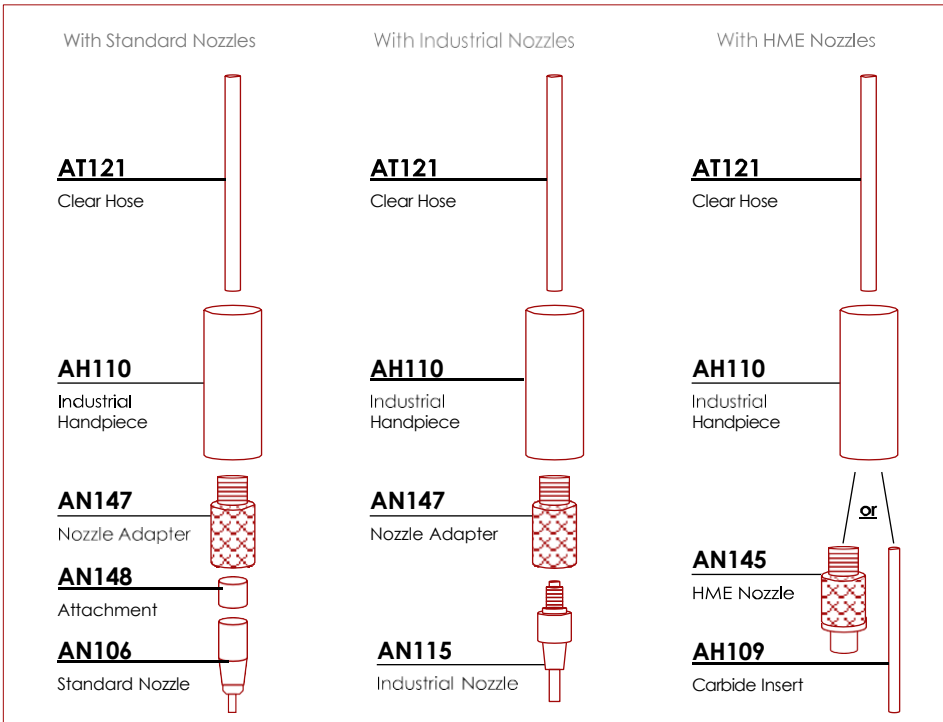

### Model 6500

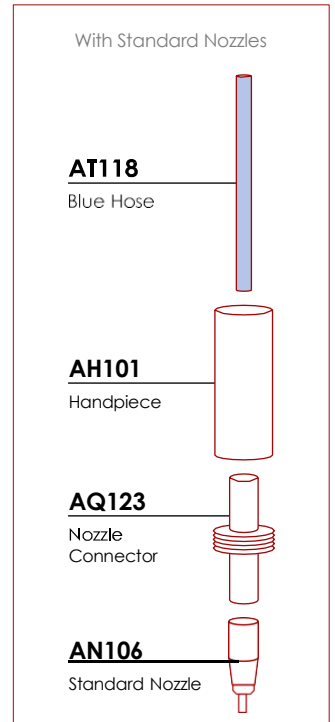

## Powder Selection Guide

Airbrasive's powders were developed specifically for use with our Micro-Abrasive Blasting Units. These powders have proven their excellent performance and reliability for many years.

Our powders are:

✓ Triple Screened

✓ Sieve Tested

✓ Vacuum Packed

✓ Purity Tested

✓ Re-sealable

✓ Shipped Overnight

Powder Type	Particle Size (μ)	Best Used For...	Very Good For...	Bottle (3-4 lb.)	Small Pail (15 lb.)	Large Pail (35-50 lb.)
Aluminum Oxide	10.0	• Abrading	• Aggressive Cleaning • Etching			AP108 (40 lb.)
	17.5	• Abrading • Aggressive Cleaning	• Etching			AP110 (45 lb.)
	27.0	• Etching	• Abrading	AP101 (4 lb.)	AP121 (15 lb.)	AP102 (50 lb.)
	50.0	• Deburring	• Abrading • Cutting • Drilling	AP105 (4 lb.)	AP123 (15 lb.)	AP106 (50 lb.)
Sodium Bicarbonate	50.0	• Coating Removal	• Delicate Cleaning			AP112 (35 lb.)
Silicon Carbide	50.0	• Cutting • Deburring	• Abrading • Drilling • Etching			AP115 (45 lb.)
Glass Bead	44.0	• Peening	• Delicate Cleaning			AP117 (40 lb.)
Crushed Glass	70.0	• Aggressive Cleaning	• Abrading			AP119 (35 lb.)

Our Customer Service team is always available to ensure your complete satisfaction. Please contact us at (866) 272-0540 or at [info@airbrasive.com](mailto:info@airbrasive.com) for general inquiries or price quote requests, and one of our team members will respond within 24 hours.